

线线连接端子系列 T Line-to-line terminal series

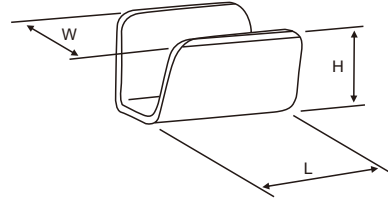

编号 Model No	适用导线 Wire Range		尺寸 Size (mm)				表面处理 Cfinish	材质 Material	相当品番 JST Equivalent code of product JST
	AWG#	mm ²	W	L	E	厚度 Thickness			
HK230BT		0.4~0.8	2.30	5.80	2.30	0.30	镀锡 Tin-plated	黄铜 Brass (H62)	
HK270BT		0.5~1.0	2.70	4.80	2.50	0.35			
HK310BT		0.5~1.25	3.10	6.10	3.00	0.40			
HK370BT		0.75~2.0	3.70	5.70	3.70	0.50			SPC-40T
HK420BT		1.3~2.6	4.20	4.00	3.90	0.50			
HK440BT		1.3~2.6	4.40	5.70	3.90	0.40			
HK680BT		2.7~6.0	6.80	6.30	6.50	0.60			

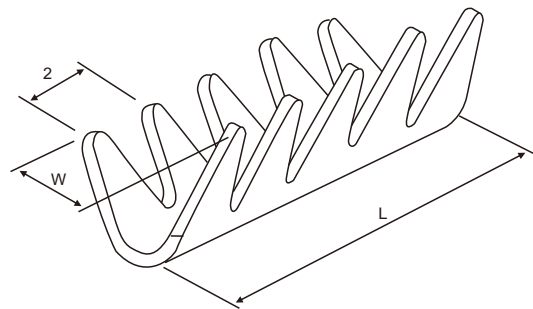
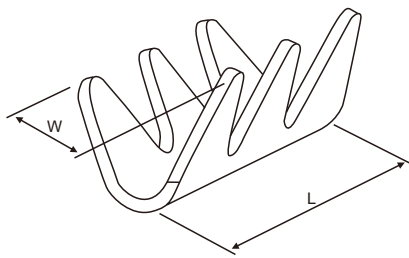

类型 Style	编号 Model No	适用导线 Wire Range	尺寸 Size (mm)			表面处理 Cfinish	材质 Material	相当品番 Equivalent code of product
		mm ²	L	W	厚度 Thickness			
A	HXK210ASB	0.75~1.0	7.00	2.10	0.25		磷青铜 Phosphor	926933-1(AMP)
	HXK250ASB	0.75~1.0	6.00	2.50				926933-2(AMP)
	HXK270ALB	1.25~2.5	7.00	2.70				925856-1(AMP)
B	HXK270ALB-M*	1.5~2.5		2.00			GF70010-1(志丰)	

注：带*号的端子依使用情况裁剪。Remarks:the number of terminal marked with * is cut according to using condition.

线线连接端子系列 T Line-to-line terminal series

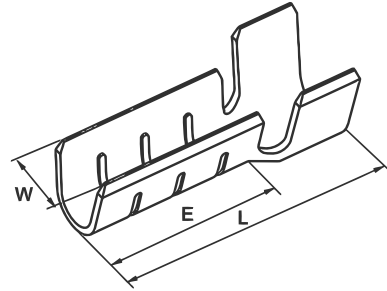

编号 Model No	适用导线 Wire Range		尺寸 Size (mm)				表面处理 Cfinish	材质 Material	相当品番 JST Equivalent code of product JST
	AWG#	mm ²	W	L	E	厚度 Thickness			
HK230BT		0.4~0.8	2.30	5.80	2.30	0.30	镀锡 Tin-plated	黄铜 Brass (H62)	
HK270BT		0.5~1.0	2.70	4.80	2.50	0.35			
HK310BT		0.5~1.25	3.10	6.10	3.00	0.40			

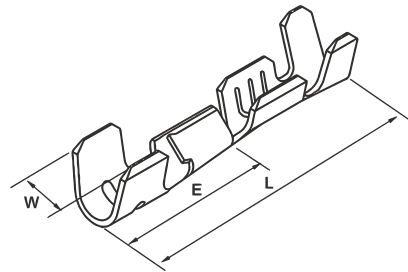
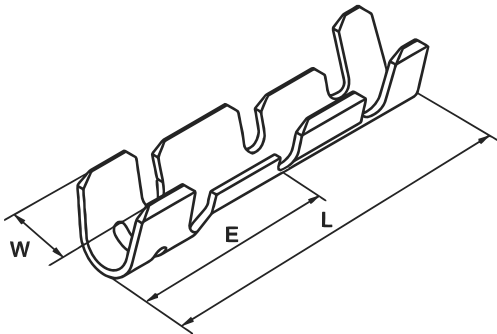

类型 Style	编号 Model No	适用导线 Wire Range		尺寸 Size (mm)				表面处理 Cfinish	材质 Material	相当品番 JST Equivalent code of product JST
		AWG#	mm ²	W	L	E	厚度 Thickness			
A	HK196B	20~16	0.5~1.0	4.50	19.6	10.2	0.40		黄铜 Brass (H62)	
	HK196BT	20~16	0.5~1.0	4.50	19.6	10.2	0.40	镀锡 Tin-plated		
B	HK190B	20~16	0.5~1.0	4.20	19.0	9.80	0.40			
	HK190BT	20~16	0.5~1.0	4.20	19.0	9.80	0.40	镀锡 Tin-plated		

焊接端子系列Welding terminal series



类型 Style	编号 Model No	适用导线 Wire Range		尺寸 Size (mm)		材料表面处理 Finish and Material	适合PCB板 plicable PCB		相当品番 JST Equivalent code of product JST
		AWG#	mm ²	D	L		厚度 Thickness	孔径 Hole Diameter	
A	HSD1.5AGBT	24~20	1.5~2.3	1.50	7.00	黄铜镀锡 Brass and Tin-plated	1.20	1.50	SIN-21T-1.8
B	HSD1.8ASBT	22~18	1.7~3.8	2.10	10.4		1.60	1.80	
	HSD1.8AMBT	18~16	2.8~3.4	2.00	10.4				
	HSD1.8ALBT	14	3.8	2.10	10.4				

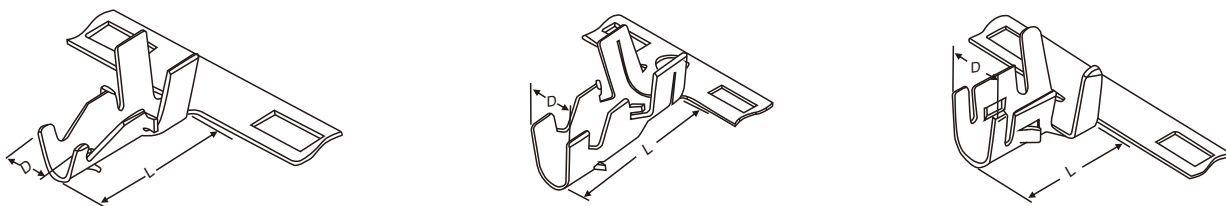

类型 Style	编号 Model No	适用导线 Wire Range		尺寸 Size (mm)		材料表面处理 Finish and Material	适合PCB板 plicable PCB		相当品番 JST Equivalent code of product JST
		AWG#	mm ²	D	L		厚度 Thickness	孔径 Hole Diameter	
A	HSD1.8ASBT-S	22~18	1.5~3.0	2.60	7.00	黄铜镀锡 Brass and Tin-plated	1.20	1.50	SIN-21T-1.8S
B	HSD2.6AGBT-S	14	3.4~3.8	3.00	7.80			1.80	SIN-61T-2.6S
C	HSD2.6AGBT	14	3.4~3.8	3.30	7.50				

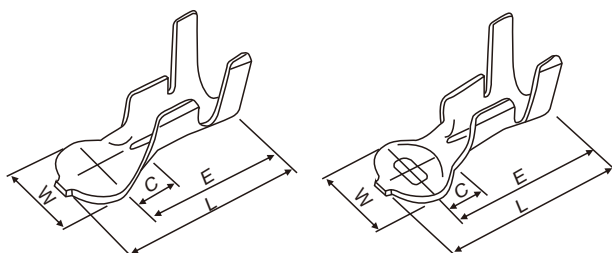

类型 Style	编号 Model No	适用导线 Wire Range		尺寸 Size (mm)				表面处理 Cfinish	材质 Material	相当品番 NT Equivalent code of product NT	
		AWG#	mm ²	W	L	C	E				厚度 Thickness
A	HZD450ASBT	24~20	2.2(Max)	4.50	11.5	3.25	9.25	镀锡 Tin-plated	黄铜 Brass (H62)	16414-0	
	HZD450AMBT	20~18	2.2~3.2	4.50	11.5	3.25	9.25			0.40	16411-0
	HZD450ALBT	20~16	1.8~3.2	4.50	11.5	2.75	9.25			0.40	16413-0
	HZD700AMBT	20~16	3.0(Max)	7.00	16.5	5.70	13.0			0.60	16902-1
B	HZD450BGBT	20~18	1.5~3.5	4.50	11.5	3.25	9.25	0.50	16412-1		

焊接端子系列Welding terminal series

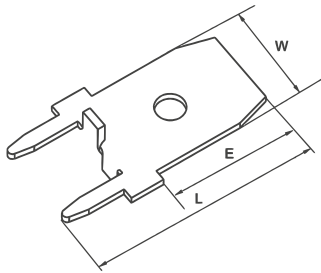

Style:A

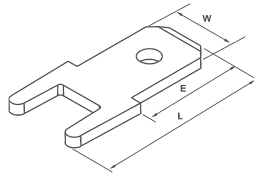

Style:B

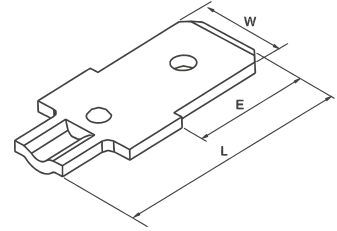

Style:C

类型 Style	编号 Model No	尺寸 Size (mm)				材料表面处理 Finish and Material	适合PCB板pplicable PCB		相当品番JST Equivalent code of product JST
		L	E	W	t		厚度Thickness	孔径Hole Diameter	
A	HSD187	14.0	6.20	4.80	0.80	黄铜镀锡 Brass and Tin-plated	1.60	1.50	
	HSD250	14.4	8.20	6.30	0.80				
B	HSD187	13.7	7.00	4.80	0.80				
	HSD250	16.4	8.00	6.30	0.80				
C	HSD187	14.5	6.50	4.80	0.80				
	HSD250	16.4	8.00	6.30	0.80				

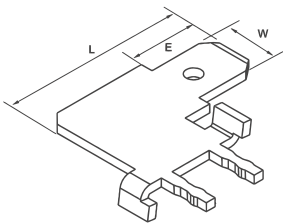

Style:A

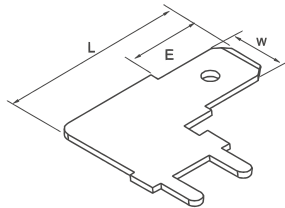

Style:B

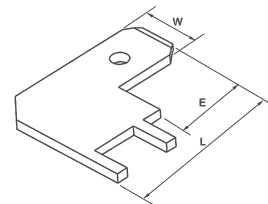

Style:C

类型 Style	编号 Model No	尺寸 Size (mm)				材料表面处理 Finish and Material	适合PCB板pplicable PCB		相当品番JST Equivalent code of product JST
		L	E	W	t		厚度Thickness	孔径Hole Diameter	
A	HSD187	15.6	6.20	4.80	0.50	黄铜镀锡 Brass and Tin-plated	1.60	1.50	
	HSD187	15.6	6.20	4.80	0.80				
B	HSD187	16.4	6.70	4.80	0.50				
	HSD187	16.4	6.70	4.80	0.80				
C	HSD187	14.5	6.50	4.80	0.50				
	HSD187	14.5	6.50	4.80	0.80				

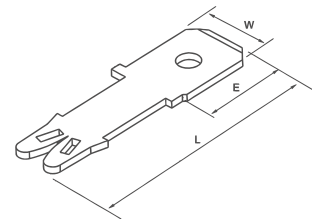

类型 Style	编号 Model No	尺寸 Size (mm)				材料表面处理 Finish and Material	适合PCB板pplicable PCB		相当品番JST Equivalent code of product JST
		L	E	W	t		厚度Thickness	孔径Hole Diameter	
	HSD480	17.0	6.25	4.80	0.50	黄铜镀锡 Brass and Tin-plated		1.50	
	HSD250	17.0	8.00	6.30	0.80			1.80	